

God had compassion.  
He did not punish the people of Nineveh.

Circle the 5 differences in the 2nd picture.

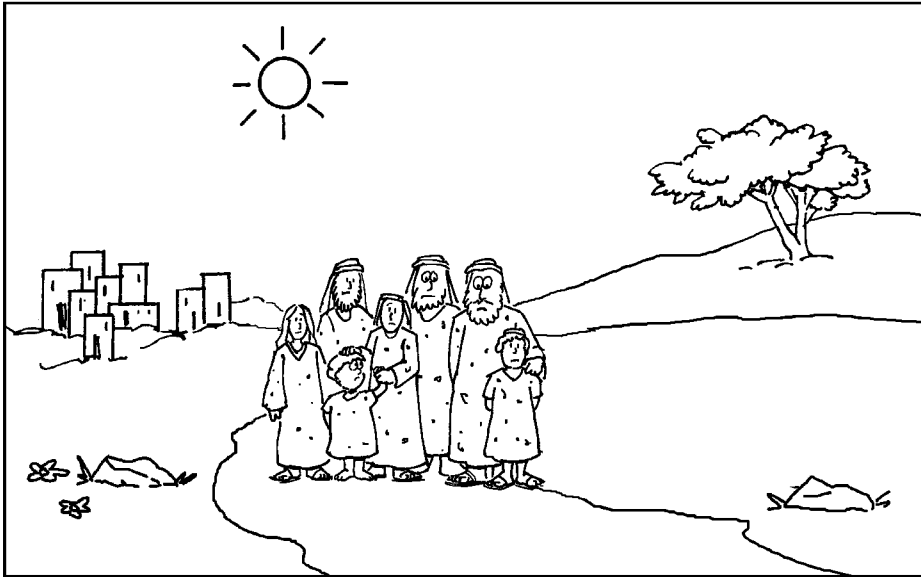

# Children's Worship Bulletin™



Ages 3+

January 24, 2021 • Jonah 3:1-5, 10

## The Repentance at Nineveh

God told Jonah to warn the people of Nineveh. Jonah obeyed.

Help Jonah get to Nineveh.

1 2 3 4 5 6 7 8 9 10 11 12

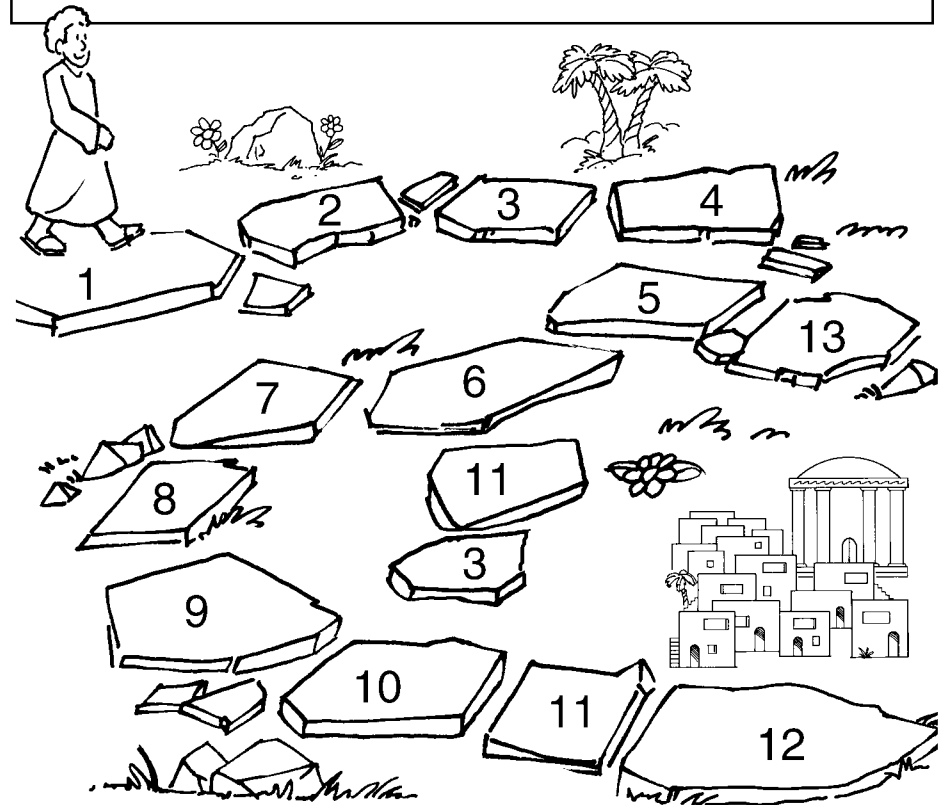

Jonah told the people of Nineveh God's plan.

Find the hidden letters in the picture.

REPENT



The people of Nineveh believed God.

Match the opposites.



Simon, Andrew, James and John  
left their boats to follow Jesus.

Use these pictures to draw the boat.

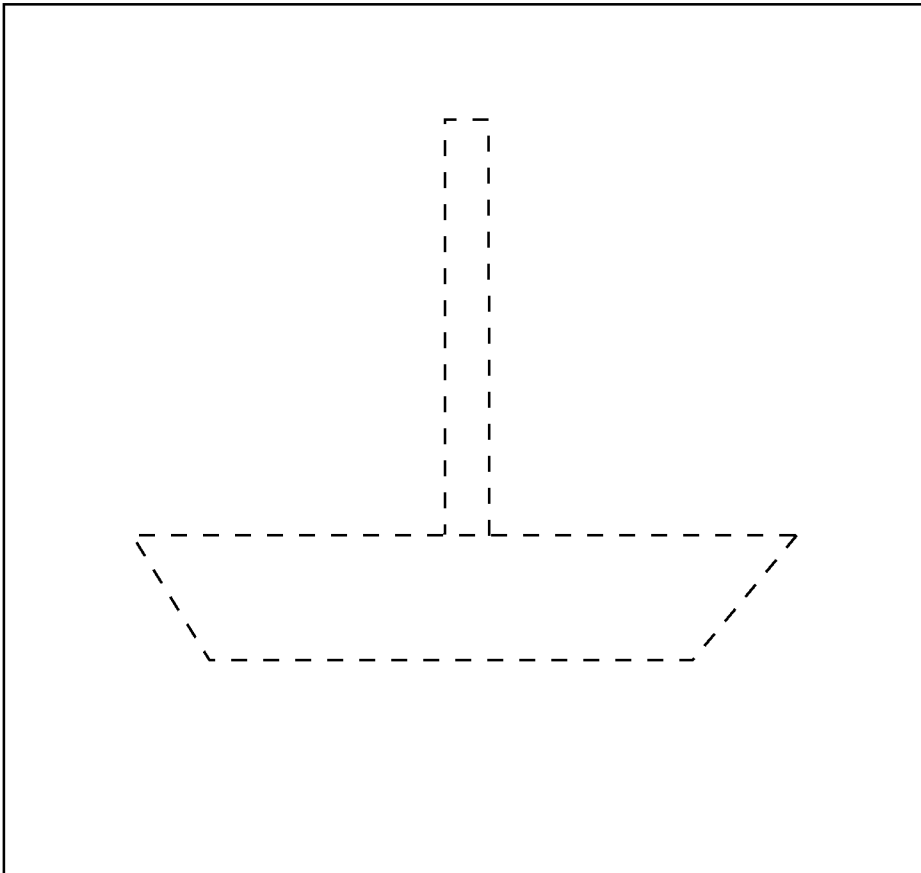
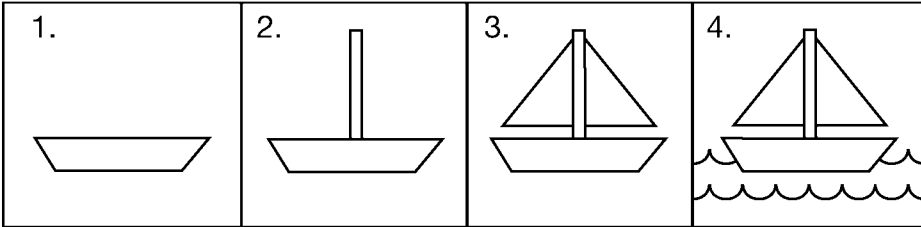

# Children's Worship Bulletin™



Ages 3+

January 24, 2021 • Mark 1:14-20

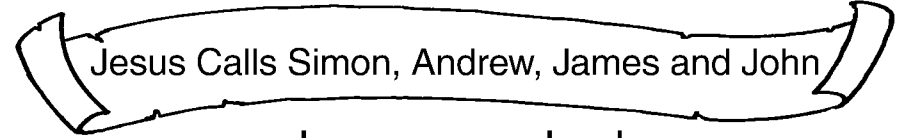

Jesus preached  
the good news of God!

Match the puzzle pieces.

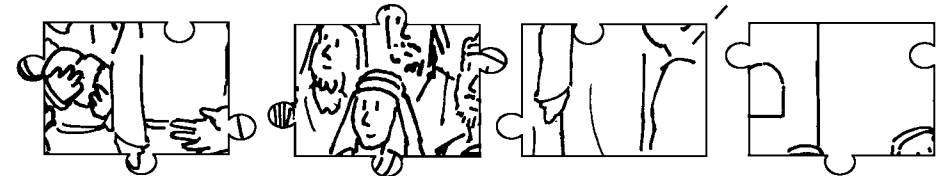
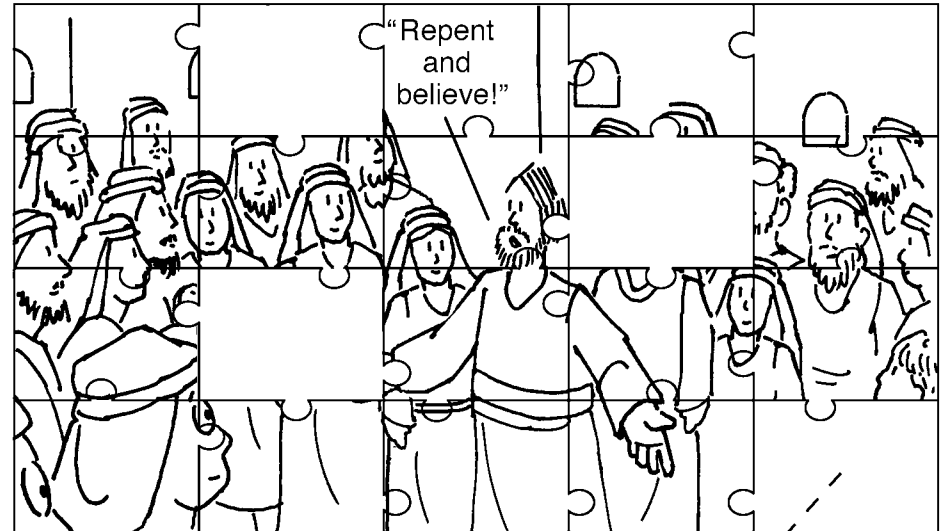

Jesus asked Simon and his brother Andrew to ...

Use the picture code.



people



fish

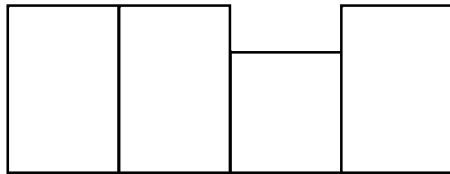

for

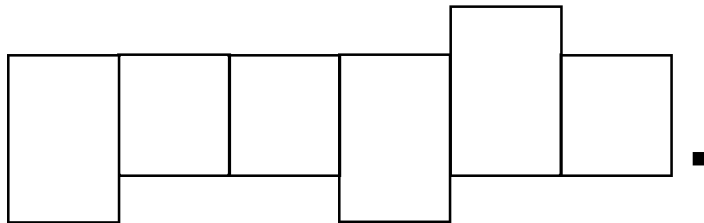

Jesus saw 2 more fishermen.  
They were James and John.

Circle

the 2 fishermen.

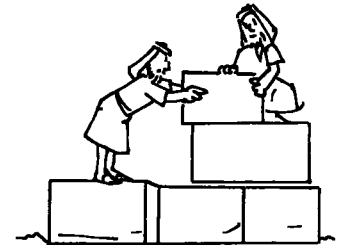
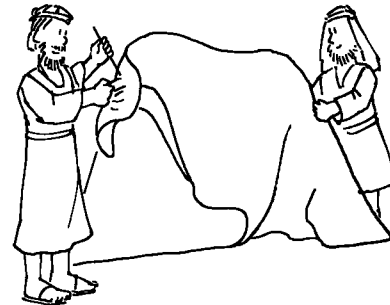
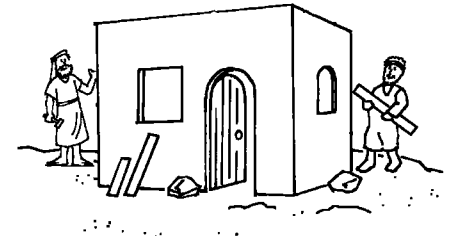

There will be a new world  
when Jesus comes.

Trace the picture.

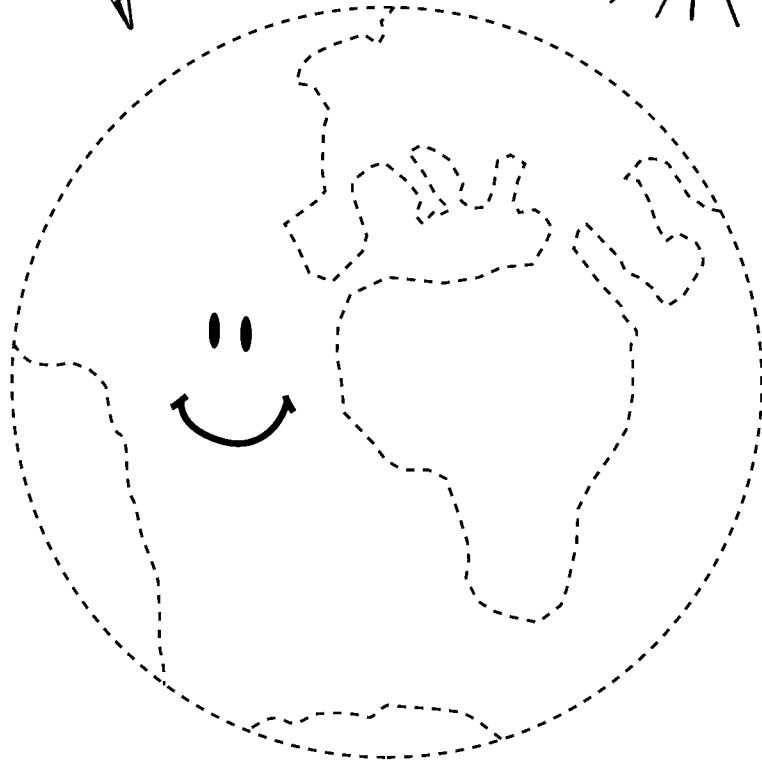
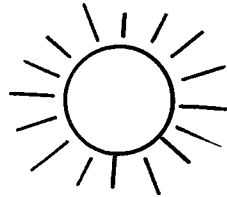
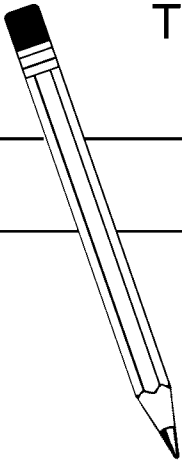

Earth

# Children's Worship Bulletin™



Ages 3+

January 24, 2021 • 1 Corinthians 7:29-31

Be Ready for Jesus to Come

Be ready! Jesus is coming!

Find  Jesus in the crowd.



It is time for Jesus to come.

Count and trace.

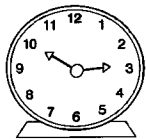
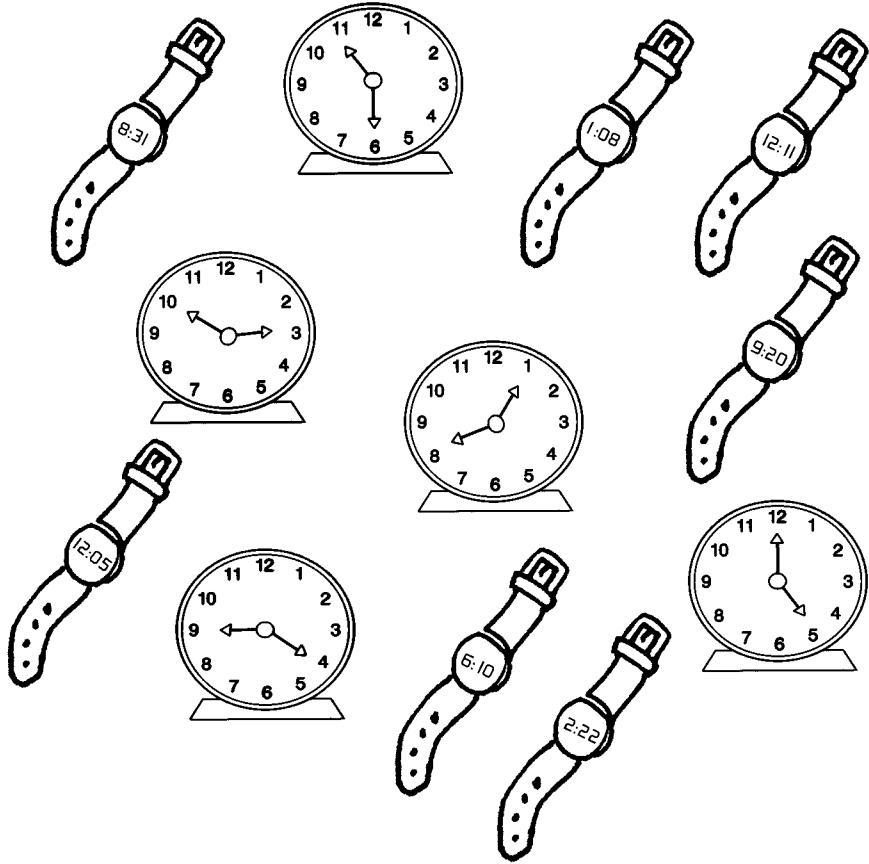

or



?

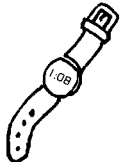

or



?

Everything will change when Jesus comes.

Match the opposites.

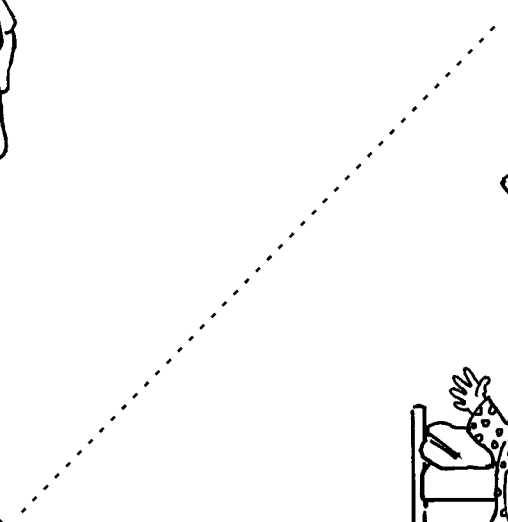
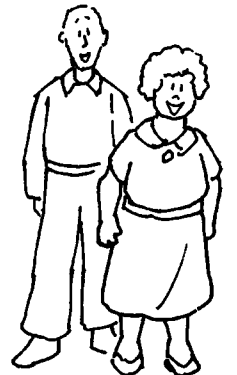
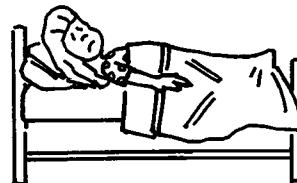
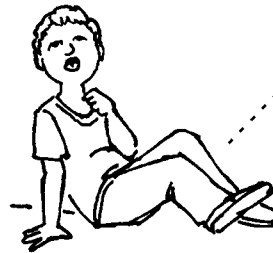



God saw how they turned from their evil ways. He did not bring them trouble as He had threatened. What did God show for the people of Nineveh?

Write the name of each picture given.  
Then transfer the letters in the O's to the lines below.



# Children's Worship Bulletin™

Ages 7+

January 24, 2021 • Jonah 3:1-5, 10

## The Repentance at Nineveh

The word of the Lord came to Jonah for the second time. What was God's message?

Connect the dots. Read the words along the path.



Jonah obeyed God and went to Nineveh.  
What did Jonah proclaim to the city?

Solve the math problems to find out.

1 = V	5 = T	9 = F	13 = O	17 = R
2 = N	6 = H	10 = A	14 = W	18 = L
3 = S	7 = Y	11 = I	15 = D	
4 = E	8 = B	12 = M	16 = U	

“

$\begin{array}{r} 5 \\ +4 \end{array}$	$\begin{array}{r} 10 \\ +3 \end{array}$	$\begin{array}{r} 12 \\ +5 \end{array}$	$\begin{array}{r} 2 \\ +3 \end{array}$	$\begin{array}{r} 5 \\ +2 \end{array}$	$\begin{array}{r} 4 \\ +8 \end{array}$	$\begin{array}{r} 15 \\ -2 \end{array}$	$\begin{array}{r} 19 \\ -2 \end{array}$	$\begin{array}{r} 6 \\ -2 \end{array}$
--	---	---	--	--	--	---	---	--

$\begin{array}{r} 9 \\ +6 \end{array}$	$\begin{array}{r} 6 \\ +4 \end{array}$	$\begin{array}{r} 9 \\ -2 \end{array}$	$\begin{array}{r} 6 \\ -3 \end{array}$	$\begin{array}{r} 15 \\ -5 \end{array}$	$\begin{array}{r} 1 \\ +1 \end{array}$	$\begin{array}{r} 17 \\ -2 \end{array}$
--	--	--	--	---	--	---

$\begin{array}{r} 6 \\ -4 \end{array}$	$\begin{array}{r} 5 \\ +6 \end{array}$	$\begin{array}{r} 9 \\ -7 \end{array}$	$\begin{array}{r} 1 \\ +3 \end{array}$	$\begin{array}{r} 9 \\ -8 \end{array}$	$\begin{array}{r} 9 \\ -5 \end{array}$	$\begin{array}{r} 2 \\ +4 \end{array}$
--	--	--	--	--	--	--

$\begin{array}{r} 5 \\ +9 \end{array}$	$\begin{array}{r} 14 \\ -3 \end{array}$	$\begin{array}{r} 21 \\ -3 \end{array}$	$\begin{array}{r} 15 \\ +3 \end{array}$	$\begin{array}{r} 5 \\ +3 \end{array}$	$\begin{array}{r} 10 \\ -6 \end{array}$
--	---	---	---	--	---

$\begin{array}{r} 9 \\ +4 \end{array}$	$\begin{array}{r} 7 \\ -6 \end{array}$	$\begin{array}{r} 12 \\ -8 \end{array}$	$\begin{array}{r} 19 \\ -2 \end{array}$	$\begin{array}{r} 9 \\ -4 \end{array}$	$\begin{array}{r} 12 \\ +4 \end{array}$	$\begin{array}{r} 13 \\ +4 \end{array}$	$\begin{array}{r} 5 \\ -3 \end{array}$	$\begin{array}{r} 3 \\ +1 \end{array}$	$\begin{array}{r} 12 \\ +3 \end{array}$
--	--	---	---	--	---	---	--	--	---

”

The people of Nineveh believed God.  
What did they do?

Use the code to find out.

A	B	C	D	E	F	G	H	I	J	K	L	M	N	O	P	Q	R	S	T	U	V	W	X	Y	Z
Z	Y	X	W	V	U	T	S	R	Q	P	O	N	M	L	K	J	I	H	G	F	E	D	C	B	A

\_\_\_\_\_

G S V B W V X O Z I V W

\_\_\_\_\_

Z U Z H G Z M W Z O O

\_\_\_\_\_

L U G S V N U I L N

\_\_\_\_\_

G S V T I V Z G V H G

\_\_\_\_\_

G L G S V O V Z H G

\_\_\_\_\_

K F G L M

\_\_\_\_\_\*

H Z X P X O L G S



\* A symbol of repentance.





When Jesus saw James and John, He called to them. How did James and John respond?

Unscramble the letters to fill in the blanks.

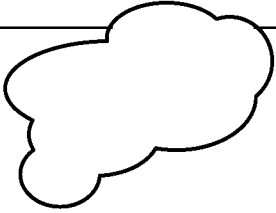
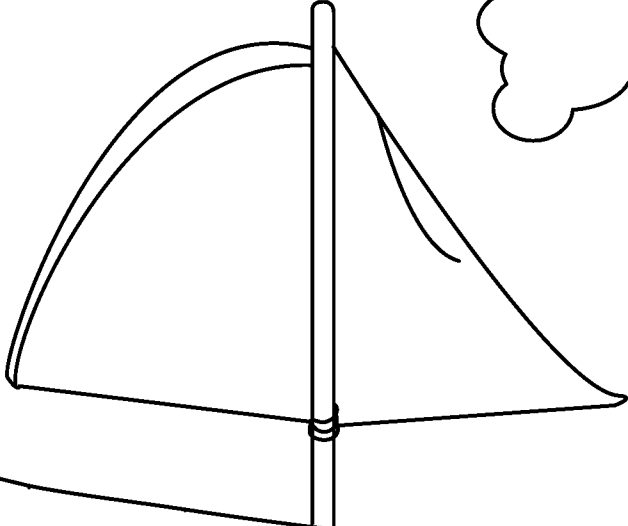

“... \_\_\_\_\_ their  
 \_\_\_\_\_ hety \_\_\_\_\_ lft  
 \_\_\_\_\_ Zebedee in the \_\_\_\_\_  
 rtfah \_\_\_\_\_ taob  
 with the \_\_\_\_\_ and  
 \_\_\_\_\_ eihrd \_\_\_\_\_ nme  
 \_\_\_\_\_ dellowfo \_\_\_\_\_ mHi.”

# Children's Worship Bulletin™

Ages 7+

January 24, 2021 • Mark 1:14-20

Jesus Calls Simon, Andrew, James and John

Jesus went into Galilee and preached. What did He say?



Use the clock code to fill in the blanks.

B	D	E	G	I	K		
L	M	N	O	P	R	T	V

“The \_\_\_\_\_ has come,”

Jesus said. “The \_\_\_\_\_

of God is near. \_\_\_\_\_

and \_\_\_\_\_

the \_\_\_\_\_ news!”

Jesus saw Simon and Andrew fishing.  
What did He say to them?

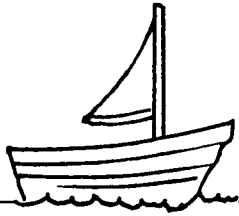

Use this code to fill in the blanks.

A	B	C	D	E	F	G	H	I	J	K	L	M	N
Z	Y	X	W	V	U	T	S	R	Q	P	O	N	M
O	P	Q	R	S	T	U	V	W	X	Y	Z		
L	K	J	I	H	G	F	E	D	C	B	A		

“ X L N V , U L O O L D

N V , Q V H F H

H Z R W , Z M W R

D R O O H V M W B L F

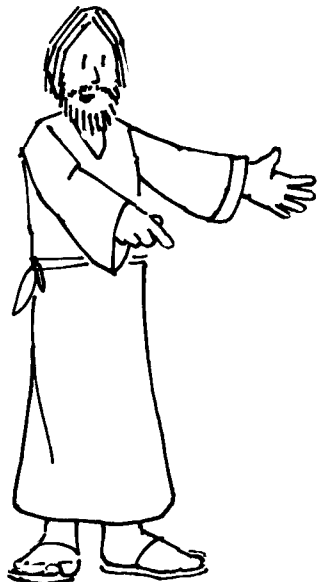

L F G G L

U R H S

U L I

K V L K O V .”

What did Andrew and  
Simon do once Jesus called them?

Add and subtract letters to find out.

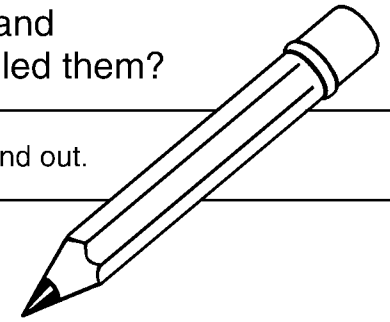

1. ARE - RE + T = \_\_\_\_\_

2. OPEN + NCE - PEN = \_\_\_\_\_

3. TABLE + FT - TAB = \_\_\_\_\_

4. NOSE + ET - OSE + S = \_\_\_\_\_

5. FISH + HOLLOW - ISHH + ED = \_\_\_\_\_

1) \_\_\_\_\_ 2) \_\_\_\_\_

they 3) \_\_\_\_\_

their 4) \_\_\_\_\_ and

5) \_\_\_\_\_

Him.

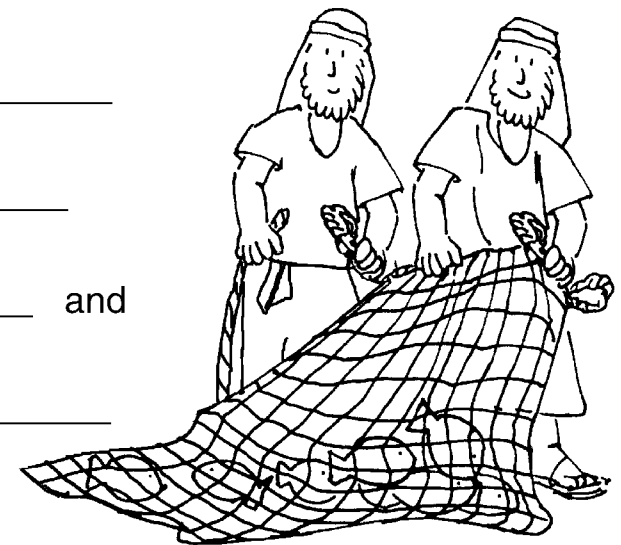



We should not allow ourselves to be taken up by things that will not last.

Fill in the missing letters in the crossword, then unscramble them to fill in the synonym (word which means the same thing) that is missing in the sentence.

Paul said we should use the things of the world but not

be \_\_\_\_\_ in them.

CROSSWORD:

Vertical words (left to right):

- 1. N T H A L L H D
- 2. N G E D
- 3. M O P L Z E D
- 4. P R B O C C U P I E D

Horizontal words (top to bottom):

- 1. E V O T E D
- 2. C O S U M E D
- 3. F A C I N A T E D

# Children's Worship Bulletin™

Ages 7+

January 24, 2021 • 1 Corinthians 7:29-31

## Be Ready for Jesus To Come

Paul reminded the Corinthian Christians that Jesus would return to earth very soon.

Use the clock to decode the message.

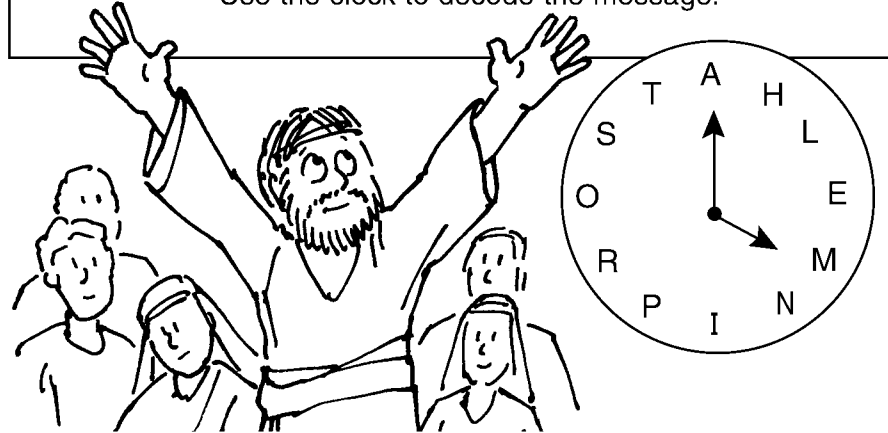

FOR

11:00 6:00 4:00 3:00 6:00 10:00 10:00 1:00 9:00 8:00 11:00

(1) \_\_\_\_\_,  
8:00 3:00 2:00 12:00 11:00 6:00 9:00 5:00 10:00 1:00 6:00 7:00 10:00

(2) \_\_\_\_\_,  
3:00 4:00 9:00 11:00 6:00 9:00 5:00 10:00

(3) \_\_\_\_\_.  
7:00 9:00 10:00 10:00 3:00 10:00 10:00 6:00 9:00 5:00 10:00

Paul told the Corinthian Christians not to be overly concerned about worldly things because ...

Use the chart to finish the sentence.



	1	2	3	4	5	6	7	8
#	M	O	U	N	T	A	I	N
\$	P	L	A	T	E	A	U	
%		B	O	U	L	D	E	R
&		C	A	N	Y	O	N	
?		W	A	T	E	R		
{		S	H	O	R	E		
/			G	U	L	F		

\$4 {3 #7 {2 ?2 #2 {5 %5 %6

#7 &4 #7 ?4 {2

\$1 ?6 \$5 {2 {6 &4 #5

/6 %3 ?6 #1 #7 {2

\$1 &3 {2 {2 #7 &7 /3 \$3 ?2 \$3 &5



Paul told them not to be overly concerned about possessions, either.

To find what Paul said, complete the code by matching the size of the coins and matching the size of the dollars. Then use the code to fill in the blanks below.

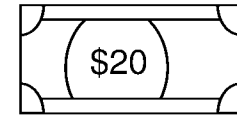
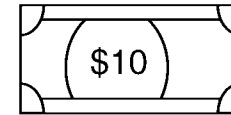
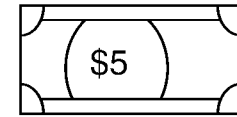
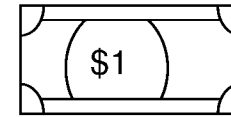
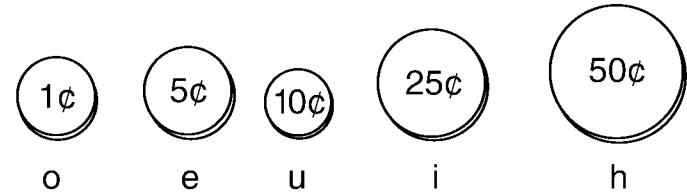

\$1 50c 1c \$5 5c \$10 50c 1c b\_\_y  
10c

\$5 1c m 5c \$1 50c 25c ng \$5 50c 1c 10c ld l\_\_v\_\_  
25c 5c

a \$5 f 25c 25c \$1 \$10 5c \$20 5c n 1c \$1

\$1 50c 5c 25c \$20 \$5 k\_\_p.  
\$1 1c 5c 5c